

## Installation Instructions for P-1500

- 1) Place dam strip (Item a) in the center of base of the opening.
- 2) Set wall jambs (Item b) on top of the dam strip in a plumb position and mark hole locations on the hinge side and bottom hole only on the latch side. Drill holes in wall (use a 3/16" carbide drill for tile walls). Insert plastic anchors (Item c) into the drilled holes. (Note: Wall jambs are supplied 67 3/4" long. If installing only a pivot door, then cut the wall jambs to 66 5/8" so that they will not extend above the hinge and latch jambs.)
- 3) Set wall jambs in place and secure with #8 x 1 1/2" P.P.H. Type A screws (Item d). Only insert bottom screw on latch side.  
Note: Door is adjustable up to 1" (1/2" at hinge jamb and 1/2" at latch jamb). Example: A P-1500 door with an opening of 24 1/2" will adjust down to 24" and up to 25". The 1" adjustment should also be used to correct out of plumb conditions. For openings up to 24 1/2", set hinge jamb all the way over the wall jamb and adjust latch jamb to meet door. For openings over 24 1/2", adjust hinge jamb out on wall jamb to compensate for additional opening width. (Diagram C)
- 4) Set latch jamb (Item e) over the wall jamb that is opposite the hinge side. Do not secure.
- 5) Set hinge jamb (Item f), with door attached, in place over the wall jamb. Adjust to fit opening and secure with #6 x 1/2" P.P.H. Tek screws (Item g).
- 6) Wet outside of handle gasket (Item h) and place on the edge of the door in the center. Tap door handle (Item i) on over gasket. The lip on the handle must be to the inside to catch on the latch (Item j).
- 7) Align latch jamb with edge of door and mark wall jamb location on wall. Remove latch jamb and secure remaining two holes in the wall jamb.
- 8) Set latch jamb over the wall jamb and adjust to 3/16" from edge of glass. Secure to the wall jamb with #6 x 1/2" P.P.H. Tek screws.
- 9) Place latch on the latch jamb in alignment with the handle and secure with #6 x 3/16" P.T.H. Type B screws (Item k).
- 10) Adjust drip rail (Item m) up at latch side of the door and down at the hinge side so that water will drain into the shower when the door is opened. Adjust the sweep vinyl (Item n) to within 1/8" of the dam strip.
- 11) Use 100% silicone to caulk the unit. Start on the outside of the unit and run caulk down both wall jambs where the wall jambs meet the wall. Then run caulk horizontally across the bottom where the drip rail meets the base. Move inside and caulk the wall jambs in the same manner as the outside. Be sure to stop caulk about six inches before the bottom on the inside. The unit is designed to allow moisture to drain back into the shower. Must not use unit for 24 hours after installation.

DIAGRAM A

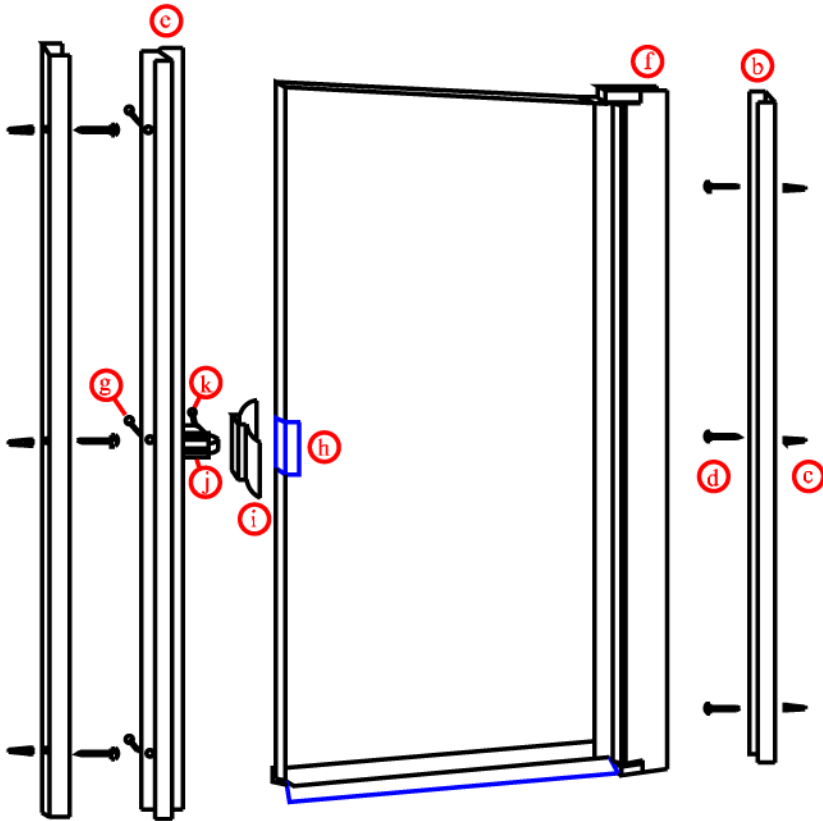

DIAGRAM B

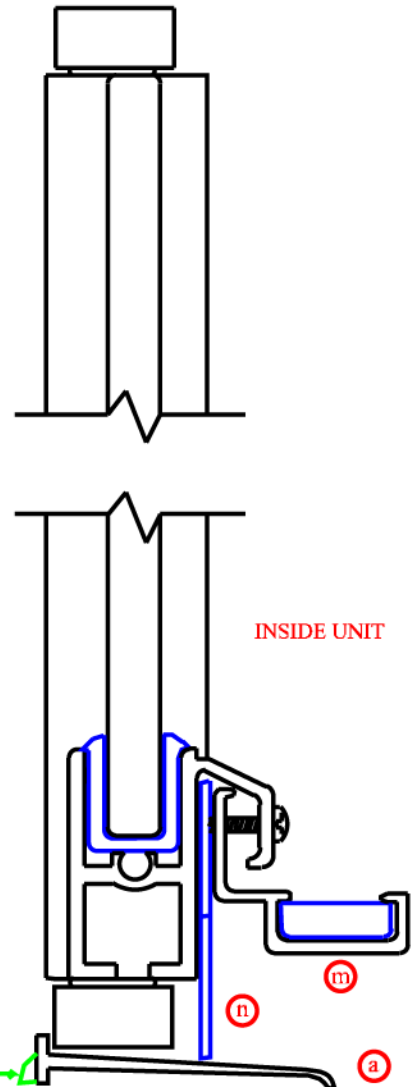

DIAGRAM C

